

SEWING MACHINE TABLE

MODULE COMFORT PRO 1.2

СТОЛ ДЛЯ ШВЕЙНОЙ МАШИНЫ



SYMBOLS



ATTENTION

ВНИМАНИЕ



ASSEMBLY & ADJUSTMENT

СБОРКА РЕГУЛИРОВКА



OPERATION

ЭКСПЛУАТАЦИЯ



STORAGE

ХРАНЕНИЕ

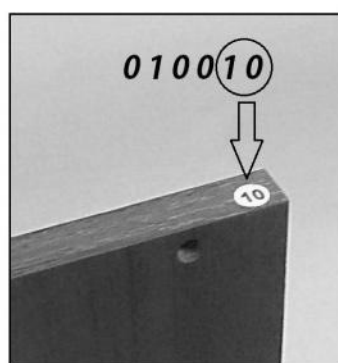

INDICATING MARK

ОБОЗНАЧЕНИЕ



SPECIAL OPERATION

СПЕЦИАЛЬНЫЕ ОПЕРАЦИИ

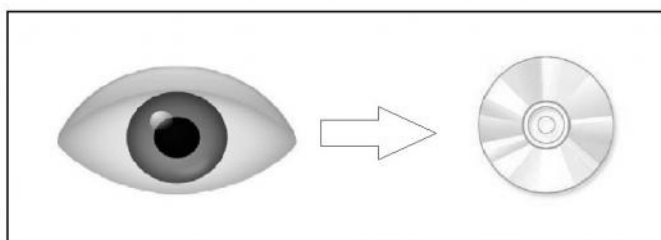

WATCH DVD

СМОТРЕТЬ DVD

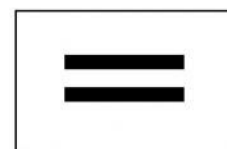

EQUALITY

РАВЕНСТВО

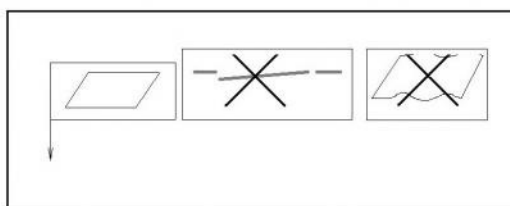

EVEN SURFACE

РОВНАЯ ПОВЕРХНОСТЬ

010001	1x	010002	1x	010004	1x	010006	1x
010008	2x	010026	1x	010034	1x		



030003  6,2 * 50 4x	030011  φ15 4x	030012  φ18 12x	030013  L = 35 12x	030015  φ8 * 30 12x	030014  φ15 h12 12x
030022  M 10 4x	030023  φ 10 4x	 φ 10 увел 4x	 4x 030029	 4x 030030	

1x  **S4**

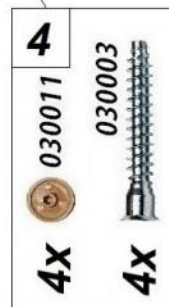
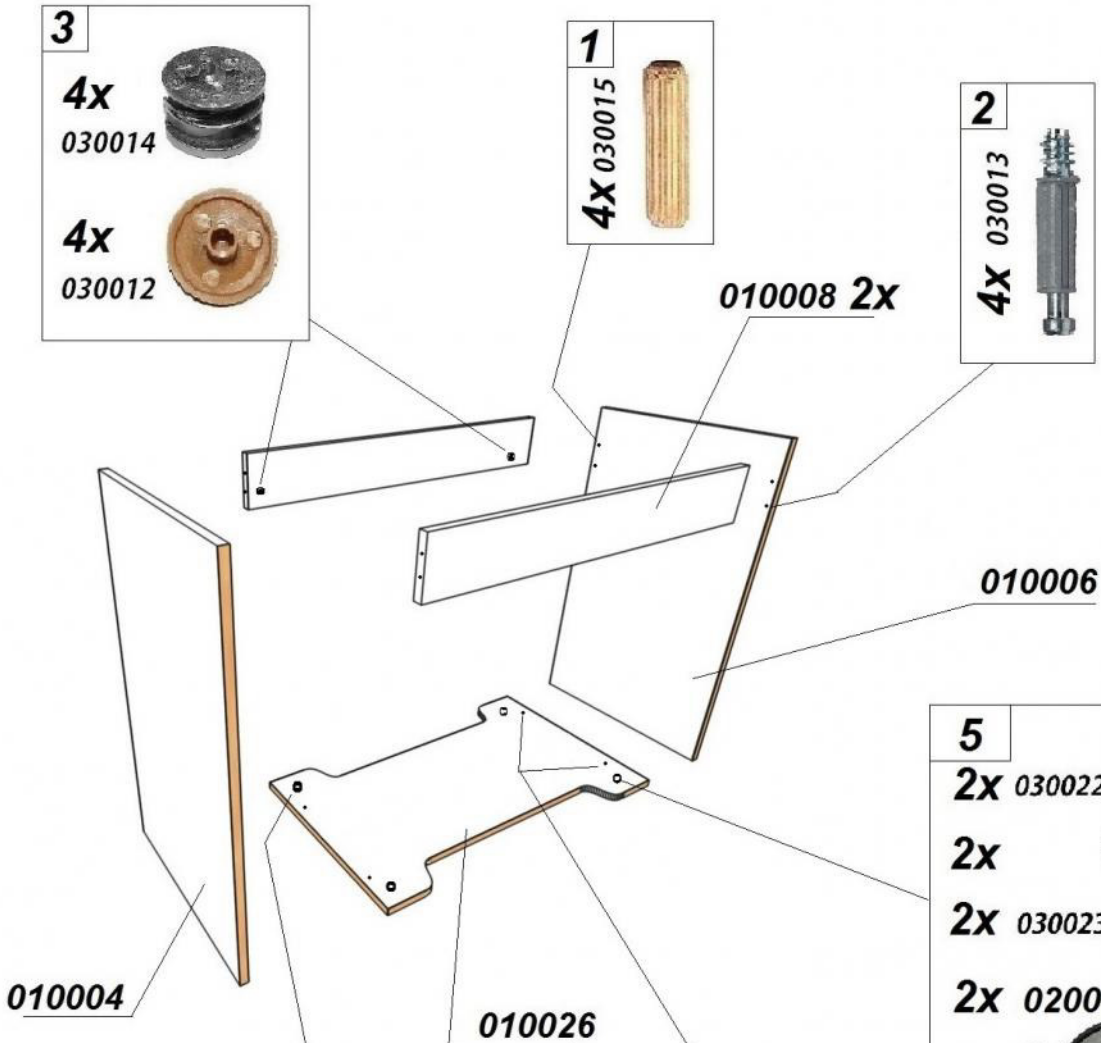
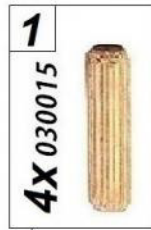

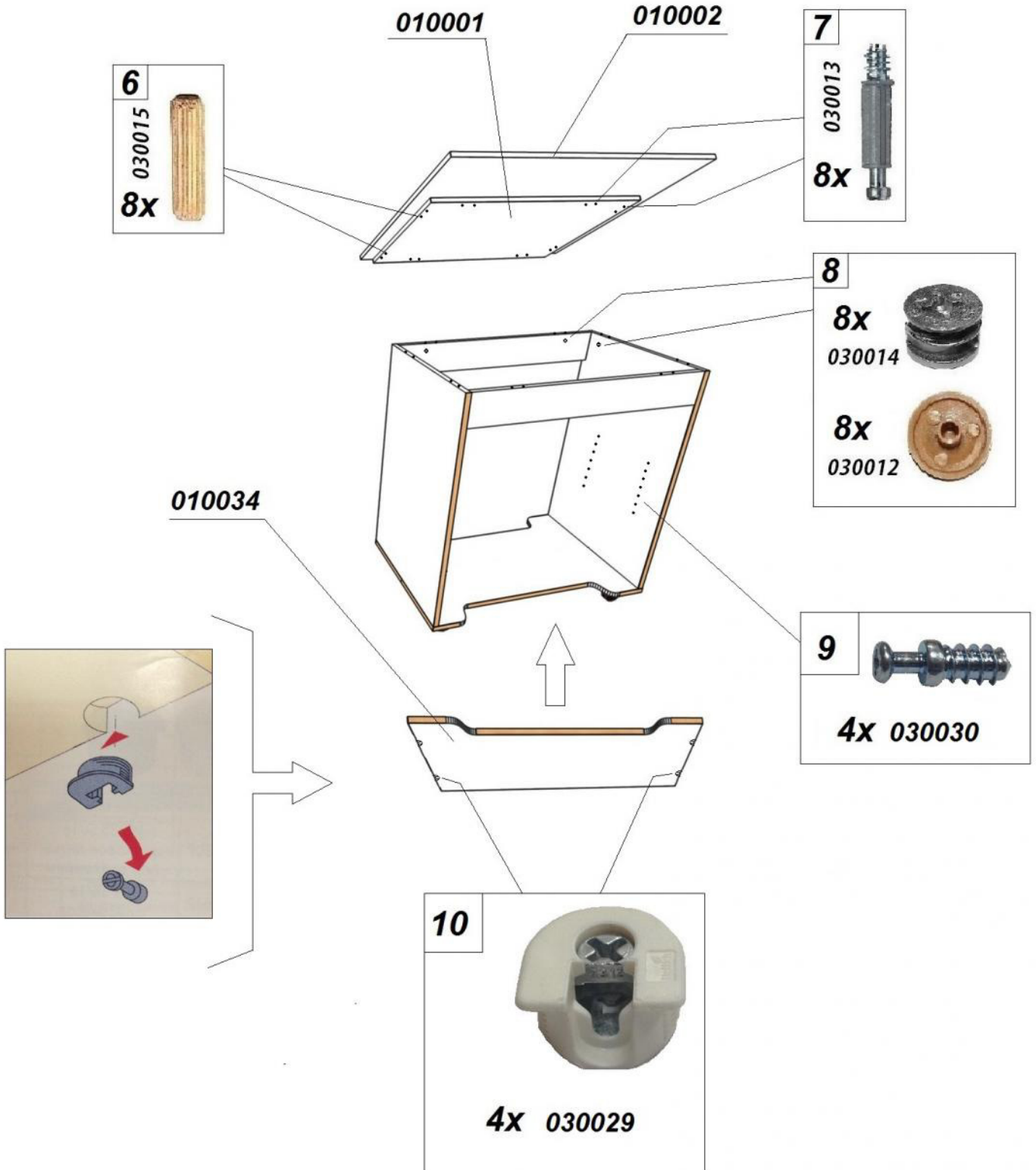

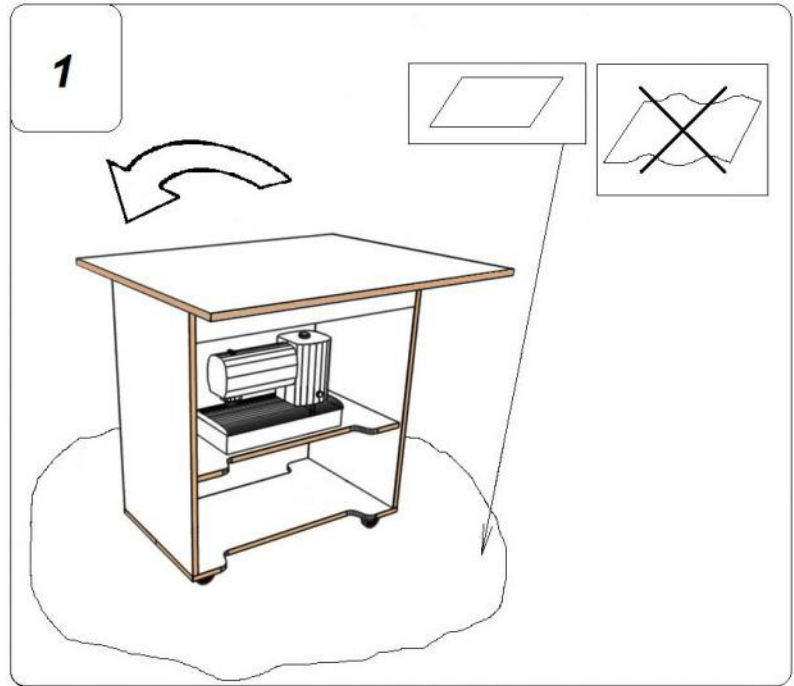

SEWING MACHINE TABLE
MODULE COMFORT PRO 1.1
MODULE COMFORT PRO 1.1 L (XL)
СТОЛ ДЛЯ ШВЕЙНОЙ МАШИНЫ



SEWING MACHINE TABLE
MODULE COMFORT PRO 1.2
СТОЛ ДЛЯ ШВЕЙНОЙ МАШИНЫ



STORAGE UNIT
MODULE COMFORT PRO 1.3
ТУМБА ДЛЯ ХРАНЕНИЯ



STORAGE UNIT
MODULE COMFORT PRO 1.4
ТУМБА ДЛЯ ХРАНЕНИЯ



МОДУЛЬНАЯ ПЛАТФОРМА
COMFORT PRO 1 (3 ЭЛЕМЕНТА)



МОДУЛЬНАЯ ПЛАТФОРМА
COMFORT PRO 1 (4 ЭЛЕМЕНТА)

